

**Manitex**



**CM300.1**

**30-ton (27 mt) TELESCOPIC CRANE**  
**CM300.1 SERIES PRODUCT GUIDE**

# CONTENTS

Crane Features .....	4
30102C / 30100C Chassis .....	5
3051T Chassis .....	6
Outrigger Extension, Reeving Diagram, Area of Operation .....	7
30102C Load Chart A-Frame: Main Boom and Jib .....	8
30102C Boom Diagram .....	9
30100C Load Chart A-Frame: Main Boom and Jib .....	10
30100C Boom Diagram .....	11
3051T Load Chart: Main Boom .....	12
3051T Boom Diagram .....	13
Technical Descriptions .....	14-15
Options .....	15

This document is non-contractual. This document is supplied for reference use only. We are constantly making improvements to our products and reserve the right that specification, equipment, and prices are all subject to change without notice or obligation.

The photographs, and /or images in this document are for illustrative purposes only and may include optional equipment and accessories and may not include all standard equipment. Refer to the appropriate Operator’s Manual and Load Charts for instructions on the proper use of this equipment to determine allowable crane lifting capacities, assembly and operating procedures. Failure to follow the appropriate operator’s manual or load chart(s) when using our equipment or to otherwise act irresponsibly may result in serious injury or death.



















The only warranty applicable to our equipment is the standard written warranty applicable to the particular product and sale. Manitex makes no other warranty, expressed or implied. Products and services listed may be trademarks, service marks or trade-names of Manitex International and /or its subsidiaries in the USA and other countries.

















All rights are reserved. Manitex® is a registered trademark of Manitex International, Inc. in the USA and many other countries.

Copyright 2013 Manitex Inc. Manitex Inc, Georgetown Texas, 78626



# KEY

	Operator aids
	Cab
	Heating / Air conditioning
	Controls
	Hoist speed
	1 - Main hoist 2 - Auxiliary winch 3 - Recovery winch
	Rope length
	Rope - standard/optional
	Rope diameter
	Permissible line pull
	Maximum line pull
	Slewing / Allowable slewing range
	Slewing gears
	Slewing brake
	Outriggers / Lifting on outriggers
	2-Person man basket
	Counterweight
	Radio remote control

	Hook block
	Distance from hook to head sheave pin
	Hook and ball
	Hydraulics
	Boom elevation angle
	Max. boom length with extension
	Boom with extension retracted
	Boom angle
	Telescoping mode
	Working radius
	Boom length
	Hydraulic actuated boom
	Full power mechanical synchronized
	Boom head / Hook block dimension
	Main boom with auxiliary head
	Tip height



## THE CM300.1 SERIES TELESCOPIC CRANE

### Maximize use and value

The CM300.1 series strikes the perfect balance between the three things customers tell us they care about most: features, cost and ease of use.

The CM300.1 offers:

- A Greer Insight™ load moment indicator, the industry’s only monitoring display that offers the feature-rich capabilities and high-resolution VGA graphics to help operators work safer and smarter
- Self-lubricating boom slider pads, to minimize maintenance costs
- A compact size; properly equipped, the 30100C is just 40 ft. long

#### Other features include:

- 30-ton capacity @ 5 ft. radius
- 102 ft. 4- section proportional boom
- 100 ft. 4-section proportional boom
- 51 ft. 3-section tractor mount
- 112 ft. boom max. tip height
- Inverted “T” cross-section boom design
- Optional fixed & telescopic jib
- A-frame front outriggers
- Out-and-down stabilizers



### USER-FRIENDLY CONTROLS

Dual operator stations are equipped with engine start/stop, foot throttle, signal horn, boom angle indicator, load chart and range diagram.

### OUTRIGGER DEPLOYMENT

Equipped with double-acting hydraulic cylinders, large pivoting pads and audible alerts when outriggers/stabilizers are in motion.

### TWO-SPEED PLANETARY HOIST

The two-speed planetary hoist lets you change line speed on the fly. Grooved drum and tapered flanges minimize rope stacking to increase productivity and minimize downtime.



### INCREASE PROFITABILITY

The versatile CM300.1 series, designed to be used with a commercial carrier, helps both owners and operators make the most of their investment.

- Travel to and between jobs at highway speed.
- Ride in comfort with a carrier suspension designed for highway driving.
- Get repairs done quickly and by qualified technicians at commercial truck centers.
- Extend the life of the crane by replacing only the chassis when necessary.

# 30102C / 30100C CHASSIS

## 30100C Model Shown

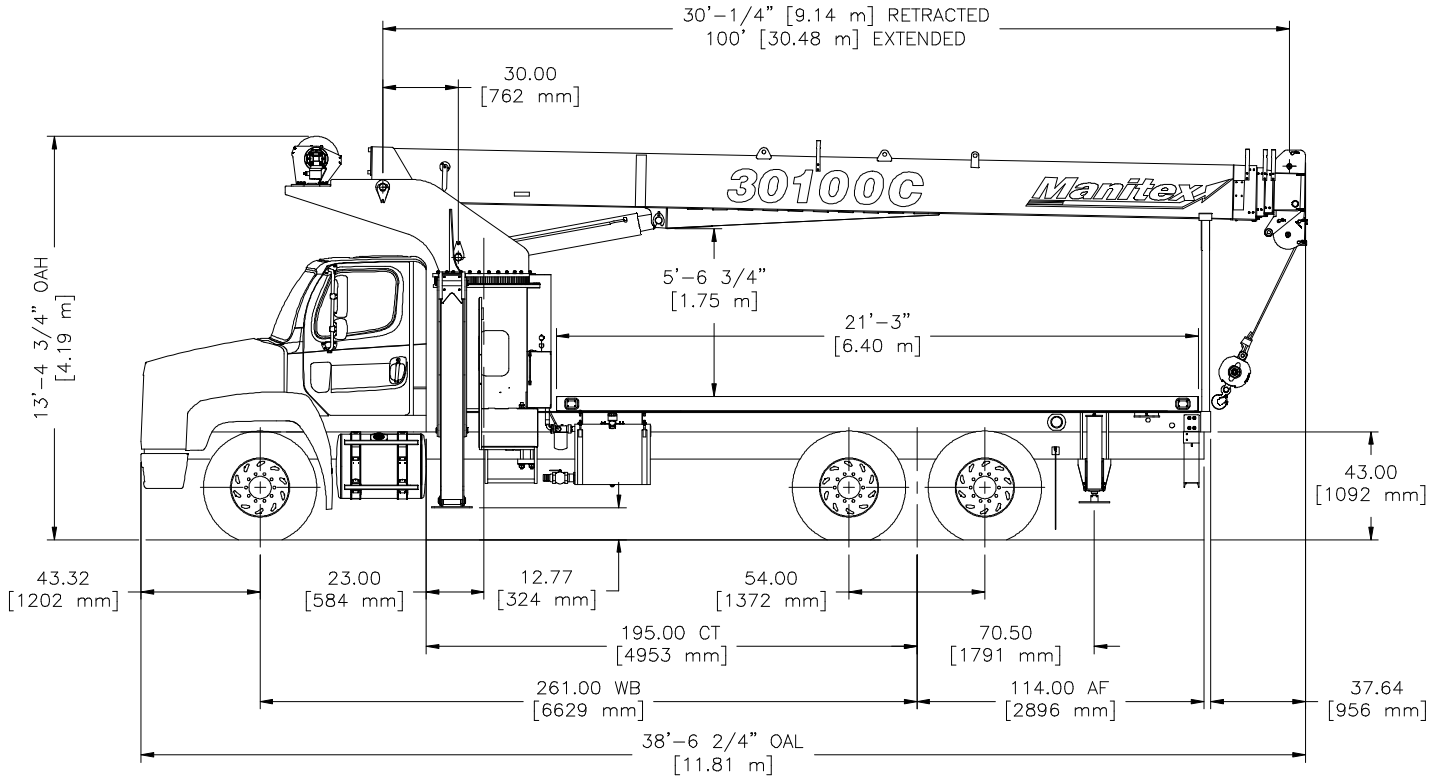

## CRANE WEIGHTS

Total Crane 30102C A-Frame	22,212 lbs. (10,075 kg)
Total Crane 30102C Out & Down	23,040 lbs. (10,451 kg)
Total Crane -30100C A-Frame	22,485 lbs. (10,199 kg)
Total Crane -30100C Out & Down	23,047 lbs. (10,454 kg)
Flatbed 22 ft. (6,7 m):	2,552 lbs. (1,144 kg)
Fixed jib: 26 ft. (7,9 m):	832 lbs. (377 kg)
Telescoping jib: 26 ft. (7,92 m) to 46 ft. (14,0 m):	1,220 lbs. (553 kg)

## TRUCK AXLE WEIGHT

Minimum truck axle weight - Front**	8,400 lbs. (3,810 kg)
Minimum truck axle weight - Rear**	8,400 lbs. (3,810 kg)
Front Axle Gross Weight Rating	18,000 lbs. (8,165 kg)
Rear Axle Gross Weight Rating	34,000 lbs. (15,422 kg)

\*\*Minimum chassis weight is required to meet 85% stability requirements. Chassis data is general - not for engineering. Some dimensions depend on truck selection.  
Notes: Additional axles required for federal bridge legal configuration - consult Manitex. Manitex highly recommends addition of a front stabilizer and may be required on some installations - consult Manitex.

## CHASSIS DATA

Wheel Base (WB)	261 in. (6,629 mm)
Cab to Tandem (CT)	195 in. (4,877 mm)
After Frame (AF)	114 in. (2,896 mm)
Nominal frame width	34 in. (864 mm)
Frame Section Modulus at 180/360° area of operation*	30 in. <sup>3</sup> (491.6 cm <sup>3</sup> ) 110,000 psi (758,423 kPa)

\*Frame selection modulus at 360° area of operation requires front bumper stabilizer.

Data published herein is intended as a guide only. Crane operation is subject to machine specific load charts and information.

# 3051T CHASSIS

## 3051T Dimensions

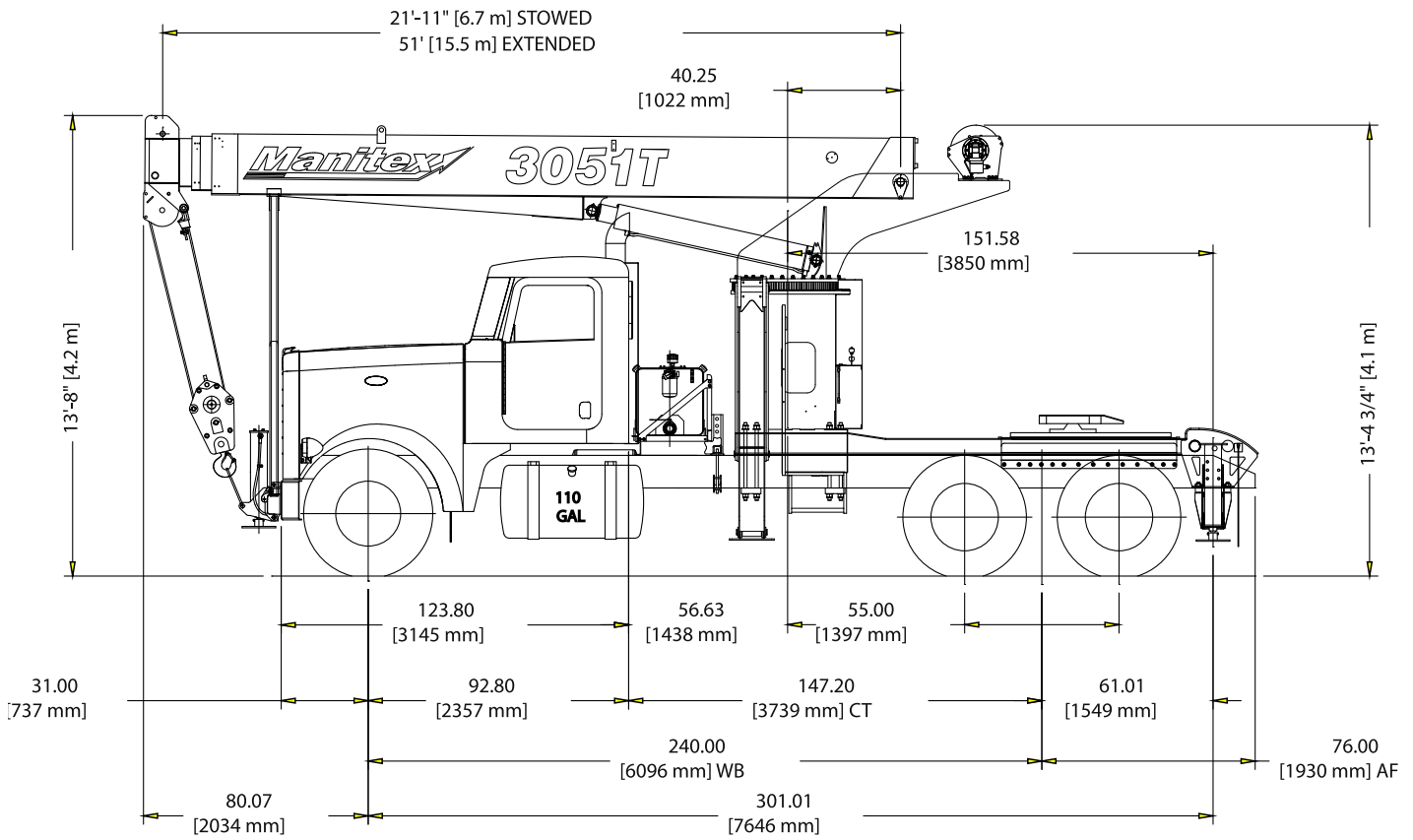

### CRANE WEIGHT

Total crane (standard):	16,129 lbs. (7,316 kg)
-------------------------	------------------------

### CHASSIS DATA

Wheel Base (WB)	240 in. (6,096 mm)
Cab to Tandem (CT)	147.2 in. (3,739 mm)
After Frame (AF)	76 in. (1,930 mm)
Nominal frame width	34 in. (864 mm)
Frame Section Modulus at 180/360° area of operation*	30 in. <sup>3</sup> (491.6 cm <sup>3</sup> ) 110,000 psi (758,423 kPa)

\*Frame selection modulus at 360° area of operation requires front bumper stabilizer.

### TRUCK AXLE WEIGHT

Minimum truck axle weight - Front**	8,400 lbs. (3,810 kg)
Minimum truck axle weight - Back**	8,400 lbs. (3,810 kg)
Front Axle Gross Weight Rating	18,000 lbs. (8,165 kg)
Rear Axle Gross Weight Rating	34,000 lbs. (15,422 kg)

\*\*Minimum chassis weight is required to meet 85% stability requirements. Chassis data is general - not for engineering. Some dimensions depend on truck selection.

Notes: Additional axles required for federal bridge legal configuration - consult Manitex. Manitex highly recommends addition of a front stabilizer and may be required on some installations - consult Manitex.



# OUTRIGGER EXTENSION

Out and Down Outrigger-Stabilizer Combination Fully Extended (optional)

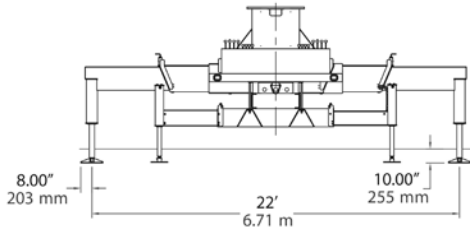

Standard Outrigger-Stabilizer Combination Fully Extended - Imperial & Metric Units

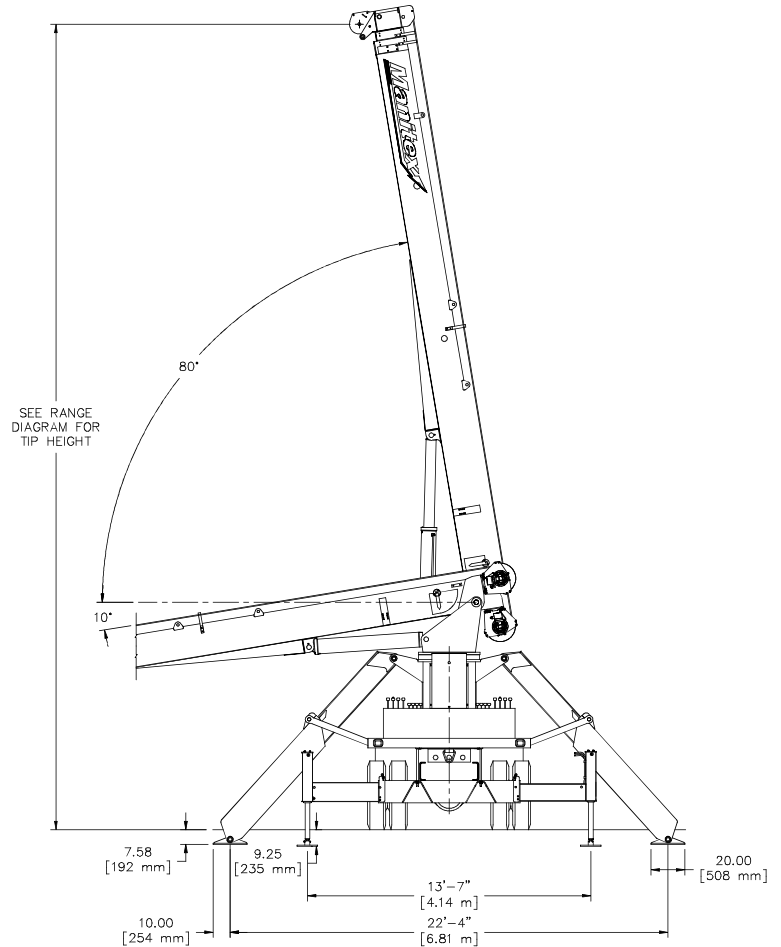

## AREA OF OPERATION

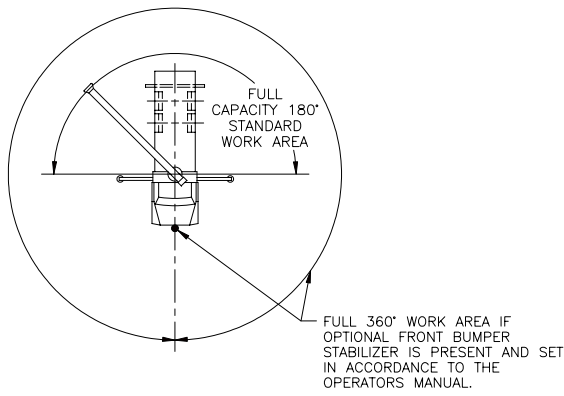

## Deductions from rated loads for load handling devices supplied by Manitex

Auxiliary block	50 lbs. (22,7 kg)
Auxiliary sheave	50 lbs. (22,7 kg)
Overhaul ball	See overhaul ball mfr. nameplate
Load blocks	See load block mfr. nameplate
Hose reel	140 lbs. (63,5 kg)
Swing around jib	See load chart

**WARNING:** Lifting off the main boom point while the jib is erected is not intended nor approved.

## ALLOWABLE LINE PULL

1 PART LINE	2 PART LINE	3 PART LINE	4 PART LINE	5 PART LINE	6 PART LINE	7 PART LINE	<b>WARNING</b>
8500 LBS	17000 LBS	25500 LBS	34000 LBS	42500 LBS	51000 LBS	60000 LBS	
7700 LBS	15400 LBS	23100 LBS	30800 LBS	38500 LBS	46200 LBS	53900 LBS	<p>ANTI-TWO-BLOCK SYSTEM MUST BE IN GOOD OPERATING CONDITION BEFORE OPERATING CRANE.</p> <p>REFER TO THE OWNER'S MANUAL.</p> <p>KEEP AT LEAST 3 WRAPS OF LOAD LINE ON THE DRUM AT ALL TIMES.</p> <p>9/16" 6X25 IWRC (3.5:1 SF) – 29750 LBS MIN BREAKING STRENGTH</p> <p>9/16" ROT RESISTANT (5.0:1 SF) – 38500 LBS MIN BREAKING STRENGTH</p>

## REEVING DIAGRAM

Data published herein is intended as a guide only. Crane operation is subject to machine specific load charts and information.

# 30102C LOAD CHART A-Frame: Main Boom and Jib

Lifting Capacities 4-section Boom 30 ft. - 100 ft.  
Jib 26 ft. - 46 ft.

 22.3 ft. (100%)

 372° Non-continuous

MAIN BOOM LMI CODE <sup>1</sup>																
30.5 ft.			42 ft. (A)		52 ft. (B)		62 ft. (C)		72 ft. (D)		82 ft. (E)		92 ft. (F)		102 ft. (G)	
	Loaded Boom Angle (deg)	Load Capacity (lbs.)	Loaded Boom Angle (deg)	Load Capacity (lbs.)	Loaded Boom Angle (deg)	Load Capacity (lbs.)	Loaded Boom Angle (deg)	Load Capacity (lbs.)	Loaded Boom Angle (deg)	Load Capacity (lbs.)	Loaded Boom Angle (deg)	Load Capacity (lbs.)	Loaded Boom Angle (deg)	Load Capacity (lbs.)	Loaded Boom Angle (deg)	Load Capacity (lbs.)
5	77	60,000														
8	71	38,600														
10	67	33,600	73	25,000	77	25,000										
12	62	29,620	71	25,000	75	25,000	78	25,000								
15	55	25,510	66	23,570	71	22,450	75	21,640	78	19,660	80	16,460				
20	42	20,200	58	18,740	65	17,730	70	17,340	74	16,760	76	14,330	79	12,180	80	10,300
25	24	15,980	50	15,770	59	14,910	65	14,220	69	13,670	73	12,570	75	10,870	77	9,390
30			39	13,220	52	12,620	60	12,020	65	11,510	69	11,100	72	9,590	74	8,500
35			26	10,380	44	10,630	54	10,360	60	9,910	65	9,530	69	8,500	71	7,630
40					35	8,220	48	8,360	55	8,460	61	8,530	66	7,790	68	6,840
45					23	6,500	41	6,650	50	6,750	57	6,810	62	6,860	65	5,920
50							33	5,370	45	5,470	52	5,540	58	5,580	62	5,190
55							22	4,380	38	4,480	47	4,540	54	4,590	58	4,570
60									31	3,690	42	3,750	49	3,800	55	3,840
65									20	3,030	36	3,110	45	3,160	51	3,190
70											28	2,570	40	2,620	47	2,660
75											20	2,110	34	2,160	43	2,200
80													28	1,770	38	1,810
85													19	1,430	33	1,470
90															27	1,180
95															18	910
DEDUCTIONS FROM MAIN BOOM CAPACITIES FOR STOWED JIB - FJ = Fixed Jib TJ = Telescopic Jib																
FJ	500 lbs.		360 lbs.		290 lbs.		250 lbs.		210 lbs.		190 lbs.		170 lbs.		150 lbs.	
TJ	740 lbs.		540 lbs.		440 lbs.		370 lbs.		320 lbs.		280 lbs.		250 lbs.		220 lbs.	

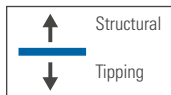

- NOTES:**
- All loads rated at 360° pick
  - Loads based on crane on fully extended outriggers and stabilizers
  - All "on outriggers" loads are based on 85% tipping
  - Loads above heavy line are based on structural rating
  - Loads below heavy line are based on tipping rating

JIB LOAD CAPACITIES						
	26 ft. Fixed Jib		26 ft. Tele. Jib		46 ft. Tele. Jib	
	Loaded Boom Angle (deg)	Load Capacity (lbs.) Code 2	Loaded Boom Angle (deg)	Load Capacity (lbs.) Code 3	Loaded Boom Angle (deg)	Load Capacity (lbs.) Code 4
25	80	5,300	80	5,100		
30	78	5,300	78	5,100	80	3,050
35	76	4,990	76	4,730	78	3,050
40	74	4,580	74	4,310	77	3,050
45	72	4,200	72	3,920	75	3,050
50	69	3,850	69	3,560	73	3,050
55	67	3,530	67	3,240	71	2,890
60	64	3,240	64	2,940	69	2,660
65	62	2,920	62	2,560	67	2,440

JIB LOAD CAPACITIES						
	26 ft. Fixed Jib		26 ft. Tele. Jib		46 ft. Tele. Jib	
	Loaded Boom Angle (deg)	Load Capacity (lbs.) Code 2	Loaded Boom Angle (deg)	Load Capacity (lbs.) Code 3	Loaded Boom Angle (deg)	Load Capacity (lbs.) Code 4
70	59	2,570	59	2,220	65	2,440
75	56	2,280	56	1,930	63	2,060
80	53	1,960	53	1,660	60	1,850
85	50	1,620	50	1,320	58	1,630
90	47	1,320	47	1,020	55	1,430
95	44	1,060	44	760	53	1,240
100	40	820	40	520	50	1,000
105	36	610			47	790
110					44	600



# 30102C BOOM DIAGRAM

## - FULL SPREAD CONFIGURATION -

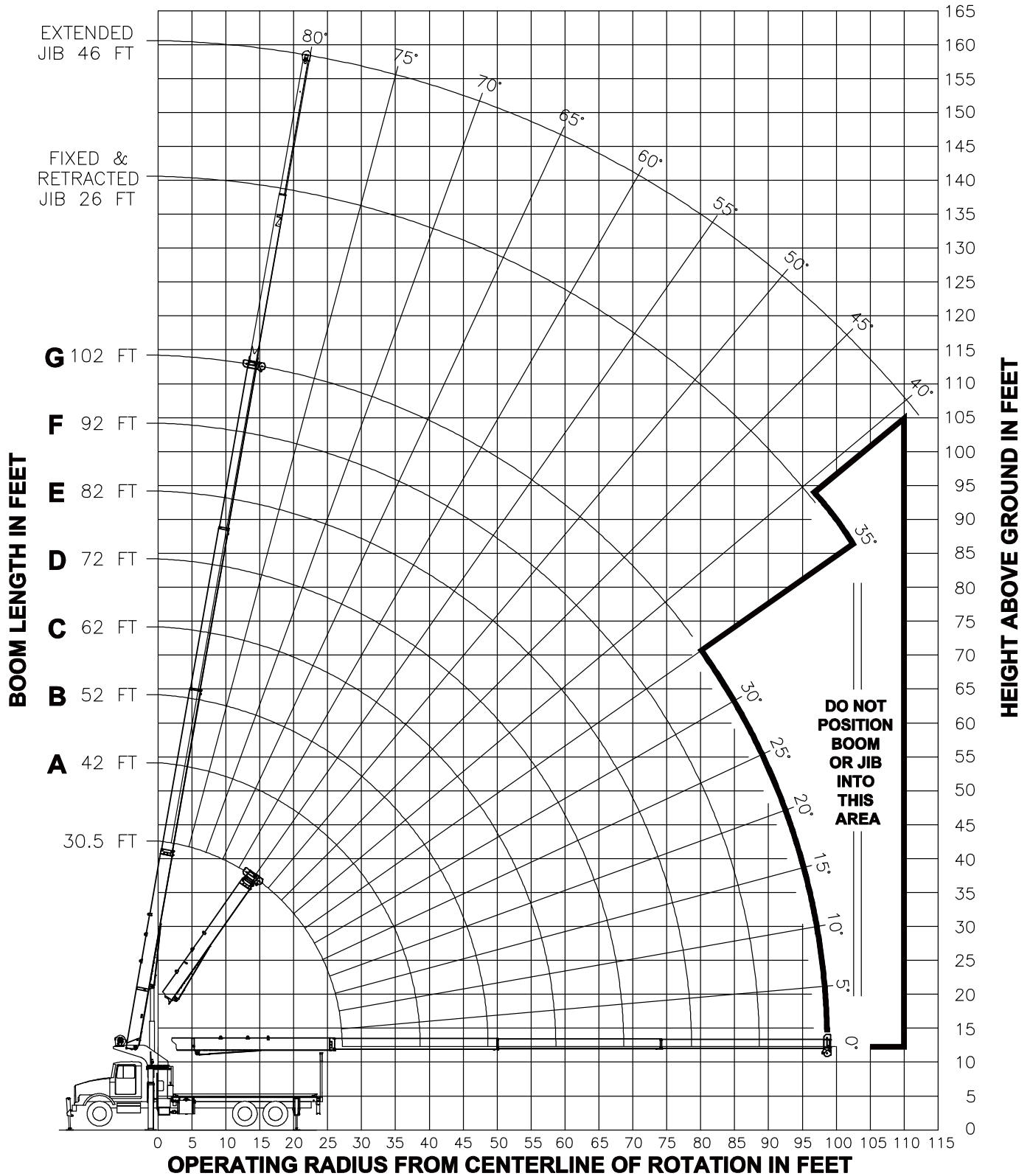

# 30100C LOAD CHART A-Frame: Main Boom and Jib

Lifting Capacities 4-section Boom 30 ft. - 100 ft.  
Jib 26 ft. - 46 ft.

 22.3 ft. (100%)

 372° Non-continuous

MAIN BOOM LMI CODE <sup>1</sup>																
30 ft.			40 ft. (A)		50 ft. (B)		60 ft. (C)		70 ft. (D)		80 ft. (E)		90 ft. (F)		100 ft. (G)	
	Loaded Boom Angle (deg)	Load Capacity (lbs.)	Loaded Boom Angle (deg)	Load Capacity (lbs.)	Loaded Boom Angle (deg)	Load Capacity (lbs.)	Loaded Boom Angle (deg)	Load Capacity (lbs.)	Loaded Boom Angle (deg)	Load Capacity (lbs.)	Loaded Boom Angle (deg)	Load Capacity (lbs.)	Loaded Boom Angle (deg)	Load Capacity (lbs.)	Loaded Boom Angle (deg)	Load Capacity (lbs.)
5	77	60,000														
8	70.5	38,800														
10	66.5	33,900	73	25,000	77	25,000										
12	62	29,830	70	25,000	74.5	25,000	78	25,000								
15	55	25,700	65.5	23,930	71	22,710	75	21,850	77.5	20,190	79.5	16,860				
20	42	20,350	57	19,060	64.5	17,980	70	17,550	73.5	16,930	76	14,660	78.5	12,470	80	10,500
25	22	15,880	47.5	16,030	58	15,140	64.5	14,410	69	13,840	72.5	12,850	75	11,080	77	9,580
30			36	13,350	50.5	12,830	59	12,200	64.5	11,670	68.5	11,250	72	9,770	74	8,540
35			19	10,360	42.5	10,630	53	10,530	60	10,060	65	9,670	68.5	8,630	71	7,770
40					32.5	8,240	46.5	8,390	55	8,490	60.5	8,560	65.5	7,910	68	6,900
45					17.5	6,520	39	6,690	49.5	6,780	56.5	6,850	61.5	6,900	65	6,000
50							30	5,410	43.5	5,510	51.5	5,580	57.5	5,630	61.5	5,250
55							16	4,410	36.5	4,520	46.5	4,590	53.5	4,640	58	4,630
60									28	3,730	41	3,800	49	3,850	54.5	3,890
65									15.5	3,080	35	3,160	44.5	3,210	50.5	3,250
70											27	2,620	39	2,670	46.5	2,710
75											15	2,160	33.5	2,220	42	2,260
80													26	1,830	37.5	1,870
85													14.5	1,480	32	1,530
90															25	1,230
95															14	960
DEDUCTIONS FROM MAIN BOOM CAPACITIES FOR STOWED JIB - FJ = Fixed Jib TJ = Telescopic Jib																
FJ	490 lbs.		370 lbs.		300 lbs.		250 lbs.		210 lbs.		190 lbs.		170 lbs.		150 lbs.	
TJ	730 lbs.		550 lbs.		440 lbs.		370 lbs.		320 lbs.		280 lbs.		250 lbs.		220 lbs.	

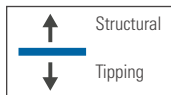

- NOTES:**
- All loads rated at 360° pick
  - Loads based on crane on fully extended outriggers and stabilizers
  - All "on outriggers" loads are based on 85% tipping
  - Loads above heavy line are based on structural rating
  - Loads below heavy line are based on tipping rating

JIB LOAD CAPACITIES						
	26 ft. Fixed Jib		26 ft. Tele. Jib		46 ft. Tele. Jib	
	Loaded Boom Angle (deg)	Load Capacity (lbs.) Code 2	Loaded Boom Angle (deg)	Load Capacity (lbs.) Code 3	Loaded Boom Angle (deg)	Load Capacity (lbs.) Code 4
25	80	5,300	80	5,100		
30	78	5,300	78	5,100	79.5	3,050
35	76	5,000	76	4,800	78	3,050
40	73.5	4,650	73.5	4,380	76.5	3,050
45	71.5	4,250	71.5	3,980	74.5	3,050
50	69	3,890	69	3,610	73	3,050
55	66.5	3,560	66.5	3,280	71	2,930
60	64	3,270	64	2,980	69	2,690
65	61.5	2,950	61.5	2,600	66.5	2,470

JIB LOAD CAPACITIES						
	26 ft. Fixed Jib		26 ft. Tele. Jib		46 ft. Tele. Jib	
	Loaded Boom Angle (deg)	Load Capacity (lbs.) Code 2	Loaded Boom Angle (deg)	Load Capacity (lbs.) Code 3	Loaded Boom Angle (deg)	Load Capacity (lbs.) Code 4
70	58.5	2,610	58.5	2,270	64.5	2,260
75	55.5	2,320	55.5	1,970	62.5	2,080
80	53	2,010	53	1,710	60	1,890
85	49.5	1,670	49.5	1,380	57.5	1,670
90	46.5	1,370	46.5	1,080	55	1,470
95	43	1,110	43	810	52.5	1,290
100	39	880	39	580	49.5	1,050
105					46.5	840
110					43.5	650

Data published herein is intended as a guide only. Crane operation is subject to machine specific load charts and information.

# 30100C BOOM DIAGRAM

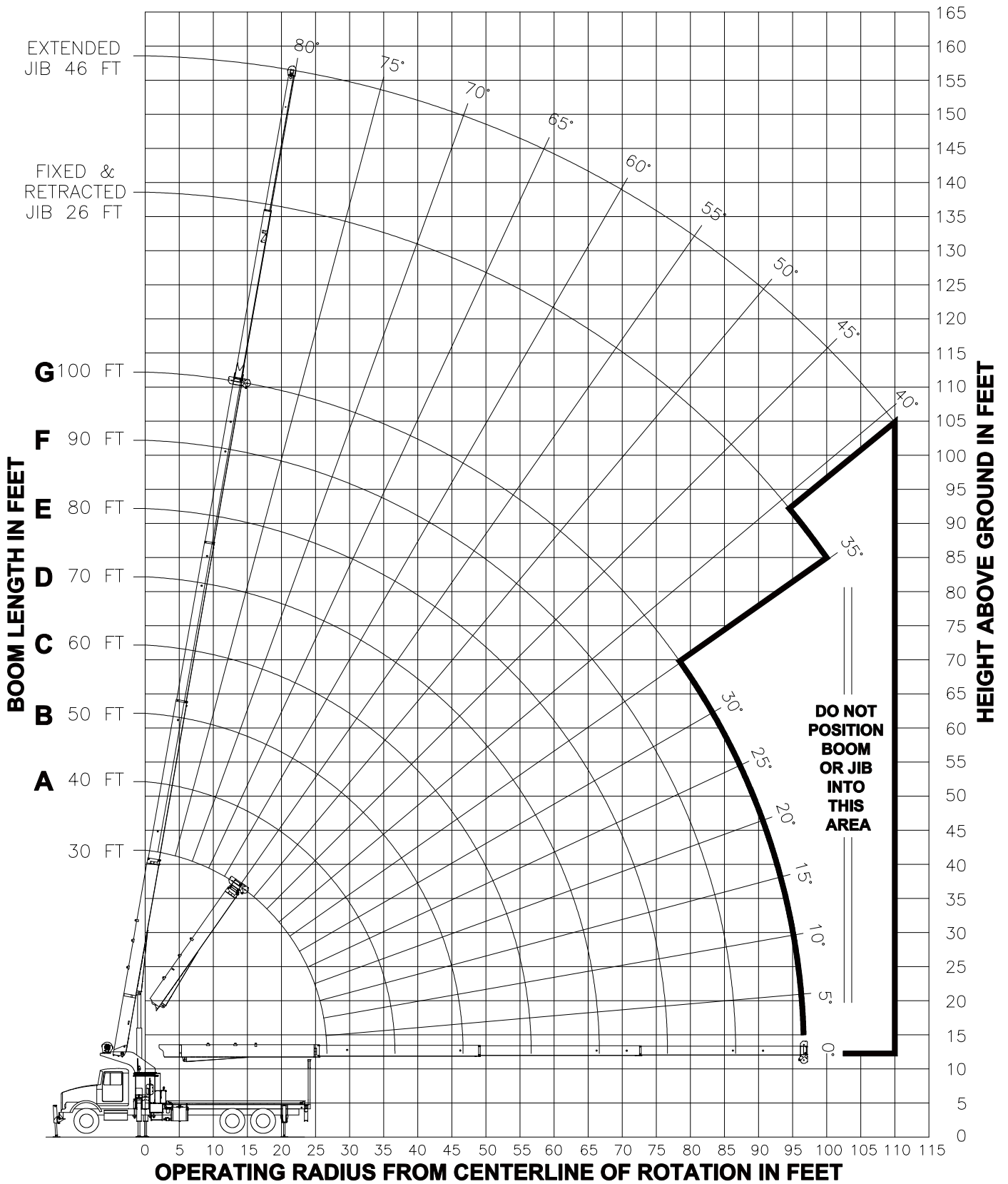

Data published herein is intended as a guide only. Crane operation is subject to machine specific load charts and information.

# 3051T LOAD CHART: Main Boom

Lifting Capacities 3-section Boom 21.27 ft.–51 ft.

 22.3 ft. (100%)

 372° Non-continuous

MAIN BOOM LMI CODE 1														
21.27 ft.			26 ft. (A)		31 ft. (B)		36 ft. (C)		41 ft. (D)		46 ft. (E)		51 ft. (F)	
	Loaded Boom Angle (deg)	Load Capacity (lbs.)	Loaded Boom Angle (deg)	Load Capacity (lbs.)	Loaded Boom Angle (deg)	Load Capacity (lbs.)	Loaded Boom Angle (deg)	Load Capacity (lbs.)	Loaded Boom Angle (deg)	Load Capacity (lbs.)	Loaded Boom Angle (deg)	Load Capacity (lbs.)	Loaded Boom Angle (deg)	Load Capacity (lbs.)
5	70	60,000												
8	60.5	43,700	66.5	41,700	71	40,100	74	38,900	76.5	38,000				
10	54	38,200	61.5	36,400	67	35,200	70.5	34,100	73.5	33,200	75.5	32,200	77	28,520
12	47	34,300	56.5	32,700	62.5	31,200	67	30,100	70.5	29,250	73	28,540	75	25,800
14	38.5	30,700	50.5	29,440	58.5	28,160	63.5	27,110	67.5	26,640	70.5	25,940	72.5	23,780
16	27.5	27,160	44.5	26,760	53.5	25,990	60	25,010	64	24,190	67.5	23,520	70.5	21,820
18			37.5	24,640	49	23,840	56	22,960	61	22,200	65	21,550	68	20,190
20			28.5	22,260	43.5	21,980	52	21,230	57.5	20,530	62	19,910	65.5	18,520
25					26.5	17,760	40.5	17,770	48.5	17,570	54.5	17,070	58.5	15,410
30							24.5	13,170	38	13,260	46	13,310	51.5	12,950
35									23	10,240	36	10,310	44	10,350
40											22	8,270	34.5	8,320
45													21	6,860
50														

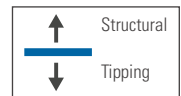

## AREA OF OPERATION

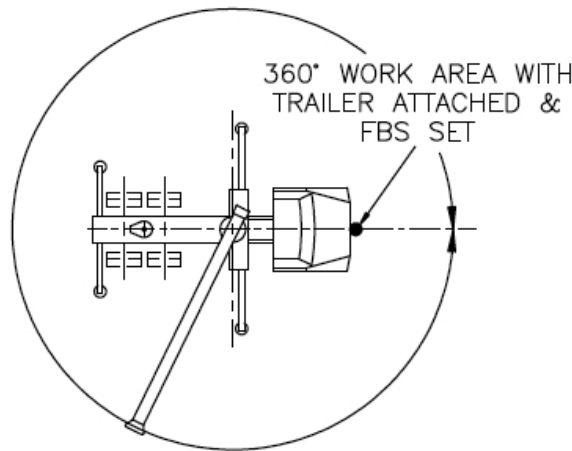

**NOTES:**

- All loads rated at 360° pick
- Loads based on crane on fully extended outriggers and stabilizers
- All "on outriggers" loads are based on 85% tipping
- Loads above heavy line are based on structural rating
- Loads below heavy line are based on tipping rating



Data published herein is intended as a guide only. Crane operation is subject to machine specific load charts and information.

# 3051T BOOM DIAGRAM

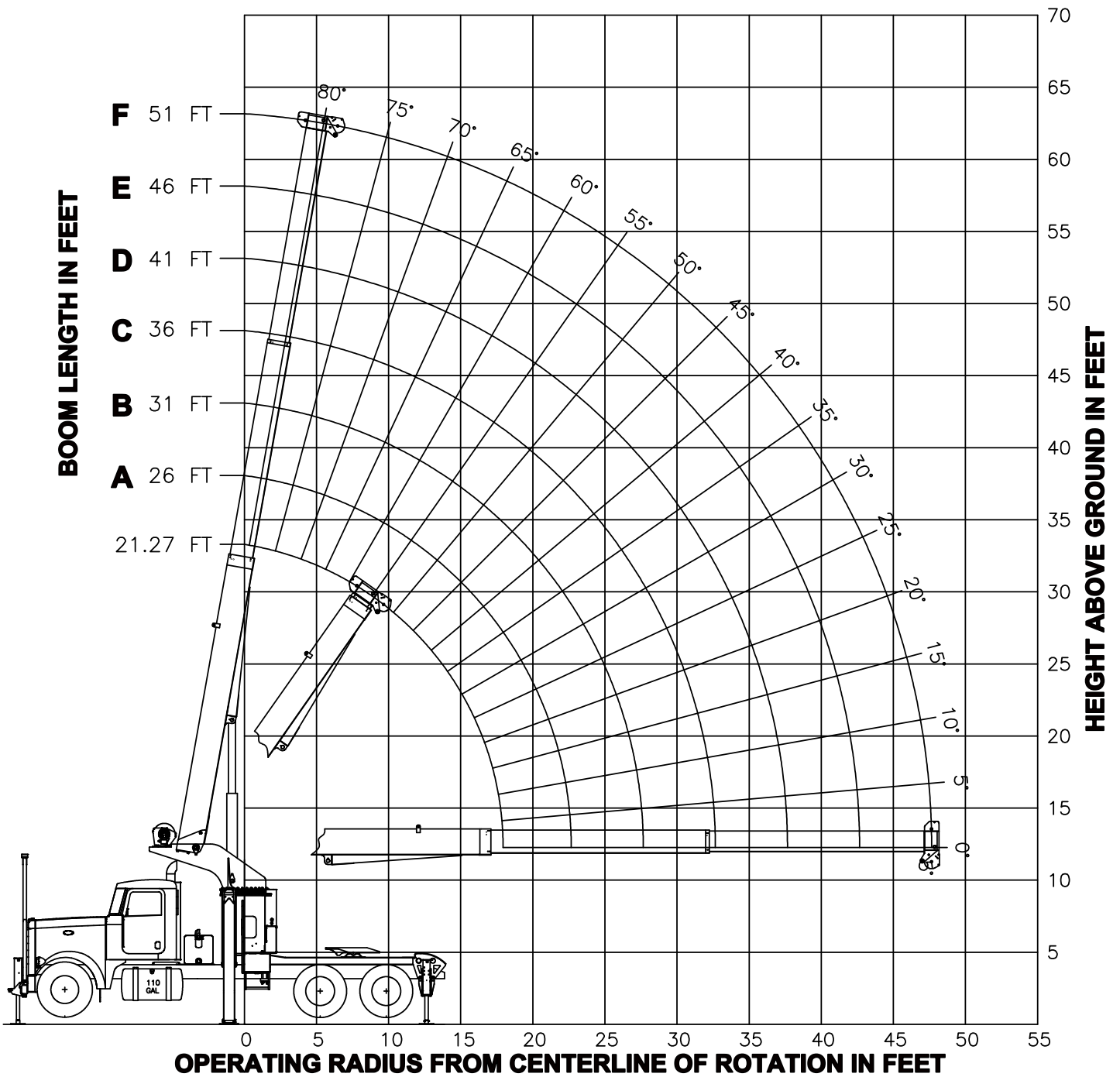

Data published herein is intended as a guide only. Crane operation is subject to machine specific load charts and information.

# TECHNICAL DESCRIPTIONS

## Boom



Boom length: Proportional boom

- 4-section 102 ft (31,1 m)
- 4-section 100 ft. (30,4 m)
- 3-section 51 ft. (15,5 m)

3-sheave quick reeve boom point  
Self lubricating slider pads



30102C:

- Boom Length 102 ft. (31,1 m)
- Boom Max. Tip Height 112 ft. (34,1 m)

30100C

- Boom length 100 ft (30,4 m)
- Boom Max. Tip Height 110.6 ft. (33,7 m)

3051T

- Boom length 51 ft. (15,5 m)
- Boom Max. Tip Height 62.3 ft. (19 m)



Boom angle (min/max): -10° / 80.6°

## Rotation



Ball-bearing swing circle with external gear  
Double-reduction planetary gearbox driven by hydraulic motor



Slewing brake: Spring-applied pressure released parking brake



Slewing speed: 0 - 1.5 rpm  
Boom rotation: 372° non-continuous

## Outriggers



Outriggers: A-frame style

FBS - Front Bumper Stabilizer (optional)

A-frame fully extended:

- 22.3 ft. (6,8 m)

Stabilizers fully extended:

- 14.6 ft. (4,4 m)

## Hoist, Rope and Hook



Maximum theoretical line speed:  
300 fpm (91,4 mpm)



Bottom Layer Permissible line pull:  
8,500 lbs. (3,855.5 kg)



Main winch cable diameter: 9/16 in.  
(14.3 mm) rotation resistant



Line length: 335 ft. (102.1 m)



Main winch: Bent axis 2-speed hydraulic motor (activated electrically)



Hook & ball: 7 T (6,4 mt) capacity hook with heavy-duty swivel and weight is provided for single line operation.

## Hydraulics



8-Bolt direct mounted PTO and SAE B input and SAE BB output

3-section gear pump, SAE BB input (standard)

Hydraulic reservoir capacity:  
70 gal. (284 L)

Pump sections @ 2000 rpm with 100 psi

- Shaft end pump: 32.4 gpm (123 lpm)
- Center pump: 20.6 gpm (78 lpm)
- Cover end pump: 10 gpm (38 lpm)

## Operator aids



Externally Wired LMI with crane function cut-offs for overload protection

Text display

Event recorder

Externally Wired anti-two block system

# TECHNICAL DESCRIPTIONS

## Control System



Dual operating stations are equipped with four single-lever crane controls arranged in accordance with ANSI B30.5 standards.

Fully proportional control valves

Each station includes:

- Individual control levers for each outrigger and stabilizer
- Engine start and stop
- Electronic foot throttle
- Signal horn
- Boom angle indicator
- Beverage holder
- Load chart with range diagram and mount for removable LMI display

## Electrical System

State-of-the-art, weather-resistant components throughout

Hermetically sealed enclosure includes power in relays and circuit status LEDs

## Mounting System

Pedestal sub-frame and stabilizers are mounted to chassis by threaded rods and clamp plates

Sub-frame: Torsion resistant, rigid 4-plate design mounted under crane full length of truck frame

Rear under-ride protection: Standard on factory mounted cranes.

Boom rest: Heavy-duty fabrication, easily removed

## Options

### Outriggers



Outriggers: Out-and-down style

- Fully extended: 22 ft. (6,7 m)

Stabilizer extended:

- Fully extended: 14.6 ft. (4,4 m)

## Options

### Jib

30102C / 30100C:

- 1-section fixed jib 26 ft. (7,9 m)
- 2-section telescopic jib 26 ft. (7,9 m) - 46 ft. (14,0 m)

### Max. Tip Height with Extension



30102C

- Max. tip height with extension: 157 ft. (47,9 m)

30100C

- Max. tip height with extension: 155 ft. (47,2 m)



30102C

- Max. tip height with extension retracted: 137 ft. (41, 8)

30100C

- Max. tip height with extension retracted: 135 ft. (41,1 m)

### Hoist, Rope and Hook



5/8 in. (15,9 mm) diameter 6 x 25 EIPS IWRC wire rope

### Hydraulics



3-section gear pump, SAE C input  
FBS - Front Bumper Stabilizer  
Hose reel - boom mounted  
Hydraulic oil cooler

### 2-Person Baskets



2-person man basket - Aluminum or steel - consult Manitex

- Non-rotating (600 lbs. cap.) - Steel
- Rotating (1,200 lbs. cap.) - Aluminum Main boom only

### Operator Aids



4-Function radio remote crane control system

- 900 Mhz
- 433 Mhz

### Tool Box & Bulkhead

- 24 in. L x 18 in. W x 18 in. H - Steel (610 mm L x 457 mm W x 457 mm H)
- 48 in. L x 24 in. W x 24 in. H - Aluminum (1219 mm L x 610 mm W x 610 mm H)
- Bulkhead: 24 in. (610 mm)

### Flatbeds

21 ft. Wood Bed x 96"  
21 ft. Heavy Hauler Steel Bed x 96"

**Manitex**



# CM300.1

**30-ton (27 mt) TELESCOPIC CRANE**  
CM300.1 SERIES PRODUCT GUIDE

**UPTIME**

UPTIME is the Manitex commitment to complete support of thousands of units working every day.

**MANITEX**

3000 South Austin Avenue  
Georgetown, Texas 78626

1-877-314-3390 | [www.Manitex.com](http://www.Manitex.com)

MTX-CM300.1-PC-EN-V3-0916