

**Manitex**



**Manitex**

# CM260

26-ton (23.6 mt) TELESCOPIC CRANE  
PRODUCT GUIDE



# CM260

26-ton (23.6 mt) TELESCOPIC CRANE  
PRODUCT GUIDE

**UPTIME**

UPTIME is the Manitex commitment to complete support of thousands of units working every day.

**MANITEX**  
3000 South Austin Avenue  
Georgetown, Texas 78626  
1-877-314-3390 | [www.Manitex.com](http://www.Manitex.com)

Manitex reserves the right that specification, equipment and prices are all subject to change without notice or obligation.

MTX-CM260-PC-EN-V2-0315



# CONTENTS

Crane Features .....	4
Boom Diagram .....	5
Load Chart: Main Boom & Jib .....	6
LMI Codes .....	7
Reeving Diagram.....	7
Crane Dimensions.....	8
Chassis Data .....	8
Crane Weights .....	8
Outrigger Extension.....	9
Area of Operation .....	9
Technical Descriptions .....	10-11
Options .....	11

Effective Date: October 1, 2014  
 This document is non-contractual. This document is supplied for reference use only. We are continuously making improvements to our products and reserve the right that specification, equipment, and prices are all subject to change without notice or obligation.  
 The photographs, and /or images in this document are for illustrative purposes only and may include optional equipment and accessories and may not include all standard equipment.  
 Refer to the appropriate Operator's Manual and Load Charts for instructions on the proper use of this equipment to determine allowable crane lifting capacities, assembly and operating procedures.  
 Failure to follow the appropriate operator's manual or load chart(s) when using our equipment or to otherwise act irresponsibly may result in serious injury or death.  
 The only warranty applicable to our equipment is the standard written warranty applicable to the particular product and sale. Manitex makes no other warranty, expressed or implied.  
 Products and services listed may be trademarks, service marks or trade-names of Manitex International and /or its subsidiaries in the USA and other countries.  
 All rights are reserved. Manitex® is a registered trademark of Manitex International, Inc. in the USA and many other countries.  
 Copyright 2013 Manitex Inc. Manitex Inc, Georgetown Texas, 78626  
 Do not operate a Manitex crane or accessories within 10' (3.04M) of live power lines.



# TECHNICAL DESCRIPTIONS

## Control System



Dual operating stations are equipped with four single-lever crane controls arranged in accordance with ANSI B30.5 standards.

Fully proportional control valves

Each station includes:

- Individual control levers for each outrigger and stabilizer
- Engine start and stop
- Electronic foot throttle
- Signal horn
- Boom angle indicator
- Beverage holder
- Load chart with range diagram and mount for removable LMI display
- System Pressure Gauge

## Electrical System

State-of-the-art, weather-resistant components throughout

Weather resistant sealed enclosure includes power in relays and circuit status LEDs

## Mounting System

Pedestal sub-frame and stabilizers are mounted to chassis by threaded rods and clamp plates

Sub-frame: Torsion resistant, rigid 4-plate design mounted under crane full length of truck frame

Rear under-ride protection: Standard on factory mounted cranes.

Boom rest: Heavy-duty fabrication, easily removed for unencumbered loading and unloading of crane deck.

## Options

### Tool Boxes & Bulkhead

- 24 in. L x 20 in. W x 18 in. H - Steel (610 mm L x 508 mm W x 457 mm H)
- 48 in. L x 24 in. W x 24 in. H - Aluminum (1219 mm L x 610 mm W x 610 mm H)
- Bulkhead: 24 in. (610 mm)

## Options

### Jib



1-section fixed jib 29 ft. (8 , 8 m)



Max. boom tip height with Optional jib: 141.9 ft. (43,25) from ground

Max. boom tip height with extension retracted: 112 ft. (35 m) from ground

### Hoist, Rope and Hook



Load block:

- 1-sheave
- 3-sheave
- 9/16" Rotation Resistant Rope

### Hydraulics



3-section vane pump, SAE B input  
 Hydraulic oil cooler  
 Hose reel - boom mounted  
 FBS - Front Bumper Stabilizer

### 2-Person Baskets



2-person man basket - Aluminum or steel - consult Manitex

- Non-rotating (600 lbs. cap.)
- Rotating (up to 1,000 lbs. cap.)

### 2-Person Baskets



4-Function radio remote crane control system

- 900 Mhz

### Bed Options

22 ft. (6,7 m) Wood or steel  
 22 ft. (6,7m) Steel heavy hauler

In order to ensure continuous improvement, Manitex reserves the right to change design and specifications without notice.

## TECHNICAL DESCRIPTIONS

### Boom

 Boom length: 4-section 101 ft. (30,8 M) proportional boom  
2-sheave quick reeve boom point

 Boom max. tip height: 112 ft. (34,3 m)  
Boom retracted tip height: 29.4 ft. (9 m)

### Rotation

 Oversized diameter ball bearing swing circle with external gear

 Slewing brake: Wet, multi-disc internal brake, spring applied, hydraulic pressure released

 Boom rotation: 372° non-continuous  
Slewing speed: 1.5 - 2 rpm. (nominal)

### Outriggers

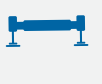
 Outriggers: A-frame  
Front

- A-frame, to outer edge of pad: 21' 6" (6,5 m)

Rear

- A-frame, to outer edge of pad: 10.1 ft. (3,1 m)

Stowed

- A-frame, to outer edge of pad: 8 ft. (2,4 m)

Outrigger motion alarm

### Hoist, Rope and Hook

 Maximum theoretical line speed: 300 fpm (91 mpm)

 Maximum theoretical bottom-layer line pull: 11,500 lbs. (5,216 kg)

 Main winch cable diameter: 9/16 in. (14,3 mm) 6 x 25 EIPS IWRC

 Line length: 300 ft. (91,4 m)

 Main winch: Gear Motor

 Load ball: 5T (4,5 mt) capacity hook with heavy-duty swivel and weight is provided for single line operation.

### Hydraulics

 6-8 bolt direct mounted PTO and SAE B or output or SAE BB output  
3-section gear pump, SAE BB input (standard)  
Counter Clockwise Rotation  
Hydraulic reservoir capacity: 70 gal. (265 L)  
Pump sections @ 2000 rpm with 100 psi



































- Shaft end pump: 32.4 gpm (123 lpm)
- Center pump: 20.6 gpm (78 lpm)
- Cover end pump: 8 gpm (38 lpm)

### Operator aids

 LMI with crane function cut-offs for overload protection  
Graphical display  
Anti-two block system - Radio with Lockout  
Outrigger Motion Alarm  
Bubble Level  
2 speed winch  
Verification Indicator

 Boom angle indicator (min/max): -10° / 80°

## KEY

	Operator aids		Hook block
	Cab		Distance from hook to head sheave pin
	Heating / Air conditioning		Hook and ball
	Controls		Hydraulics
	Hoist speed		Boom elevation angle
	1 - Main hoist 2 - Auxiliary winch 3 - Recovery winch		Max. boom length with extension
	Rope length		Boom with extension retracted
	Rope - standard/optional		Boom angle
	Rope diameter		Telescoping mode
	Permissible line pull		Working radius
	Maximum line pull		Boom length
	Slewing / Allowable slewing range		Hydraulic actuated boom
	Slewing gears		Full power mechanical synchronized
	Slewing brake		Boom head / Hook block dimension
	A-Frame outriggers		Main boom with auxiliary head
	2-Person man basket		Tip height
	Counterweight		
	Radio remote control		





## THE CM260 TELESCOPIC CRANE

### Maximize Rental Use and Value

The CM260 telescopic crane strikes the perfect balance between the three things customers tell us they care about most in a rental crane: features, cost and usability. Competitively priced and packed with standard features designed to save time and money.

- Change line speed on the fly and minimize rope stacking with its 2-speed burst of speed (combined flow) planetary hoist with grooved drum and negative draft flange.
- Minimize maintenance costs with replaceable, self-lubricating boom slider pads equipped with teflon inserts.
- Get active and immediate feedback on load with the integrated load-moment indicator system.

### Other features include:

- 26-ton Capacity @ 5 ft. radius
- 101 ft. 4-Section proportional boom
- 112 ft max boom tip height
- Optional 29' Fixed Jib
- Wired anti-two block with lockout ATB
- Removable boom rest

### USER-FRIENDLY CONTROLS

Dual operator stations are equipped with engine start/stop, foot throttle, signal horn, boom angle indicator, load chart and range diagram.



### OUTRIGGER DEPLOYMENT

An audible alarm sounds as outriggers are being deployed, and indicator lights verify when they are fully extended.

### LOAD MOMENT INDICATOR

The load-moment indicator provides audio/visual warning or shuts down the machine when lift limitations are about to be exceeded.

### INCREASE PROFITABILITY

The versatile CM260, designed to be used with a commercial carrier, helps both owners and operators make the most of their investment.

- Travel to and between jobs at highway speed.
- Ride in comfort with a carrier suspension designed for highway driving.
- Get repairs done quickly and by qualified technicians at commercial truck centers.



## OUTRIGGER EXTENSION

Imperial & Metric Units

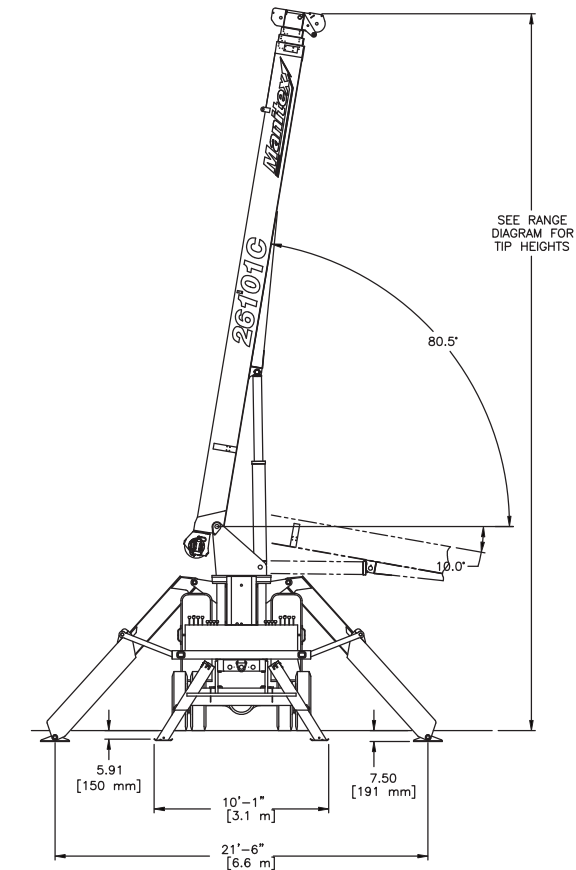

## AREA OF OPERATION

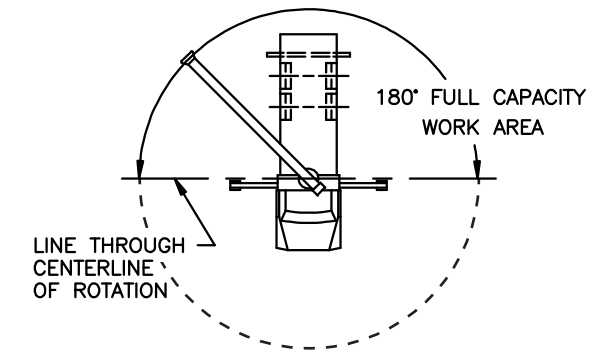

Note: 360 degree Area of Operation when equipped with optional Front Bumper Stabilizer.

### Deductions from rated loads for load handling devices supplied by Manitex

Auxiliary Block	50 lbs.
Auxiliary Sheave	50 lbs.
Overhaul ball	See overhaul ball mfr. nameplate
Load blocks	See block mfr. nameplate
Hose reel	140 lbs.
Swing-around jib	See load chart

**WARNING:** Lifting off the main boom point while the jib is erected is not intended or approved.

Data published herein is intended as a guide only. Crane operations is subject to machine specific load charts and information.



# CRANE DIMENSIONS

Imperial & Metric Units

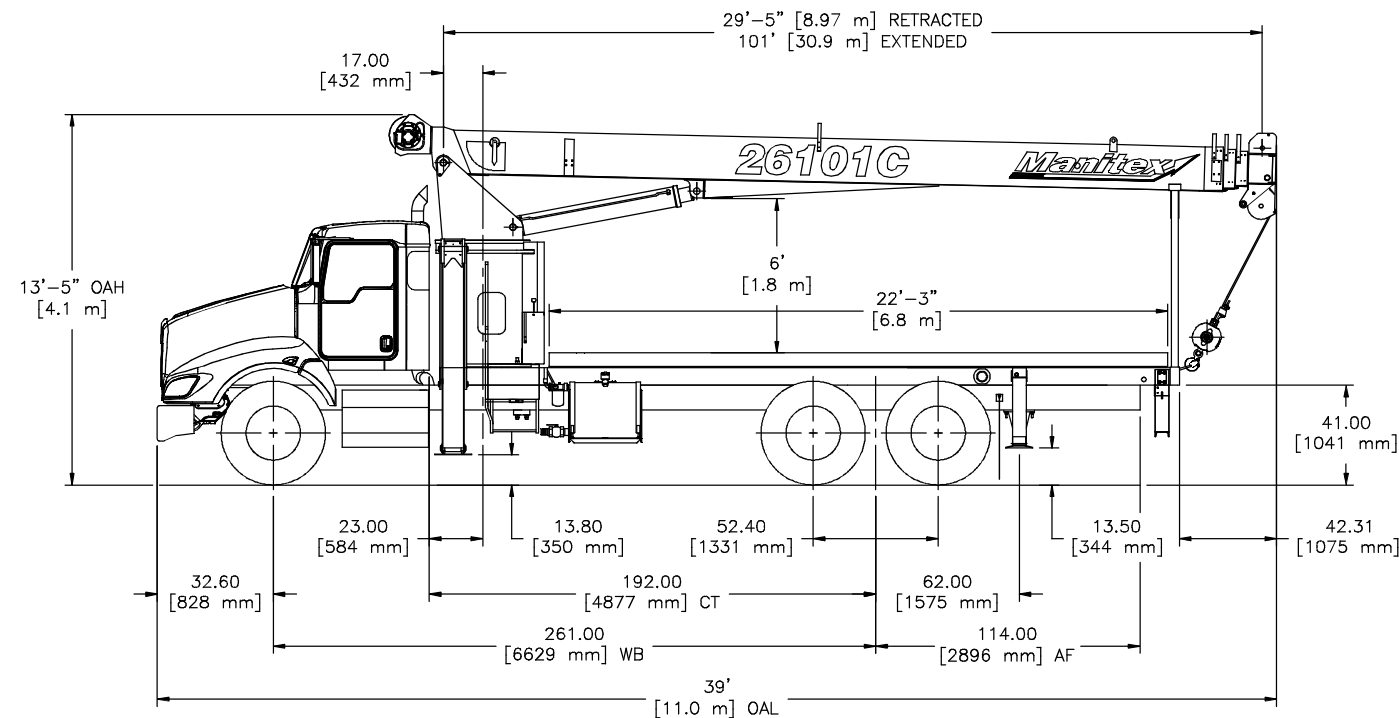

## CHASSIS DATA

Wheelbase (WB):	261 in. (6,629 mm)	Minimum truck axle weight - front*	8,000 lbs. (3,629 kg)
Cab to Tandem (CT):	192 in. (4,877 mm)	Minimum truck axle weight - rear*	8,000 lbs. (3,629 kg)
After frame (AF):	114 in. (2,896 mm)	Nominal frame W:	34 - 35 in. (864 - 889 mm)
Frame section modulus at 180°/360° rotation (min.):	15.9 in. <sup>3</sup> - 110,000 psi (758,422 kPa)	Front axle gross weight rating:	16,000lb ( 7,257 kg)
		Min. Rear axle gross weight rating:	40,000 lbs. (18,14 kg)

## CRANE WEIGHTS

Basic crane weight:	18,970 lbs. (8,605 kg)
Fixed jib 29 ft. (8,8 m):	630 lbs.
Flatbed 22 Ft (6,7 mm):	2,000 lbs. (907 kg)

\* Flatbed weight not included in crane weight.

Notes: The addition of a front stabilizer is highly recommended and may be required on some installations - consult Manitex.

Data published herein is intended as a guide only. Crane operations is subject to machine specific load charts and information.

# BOOM DIAGRAM

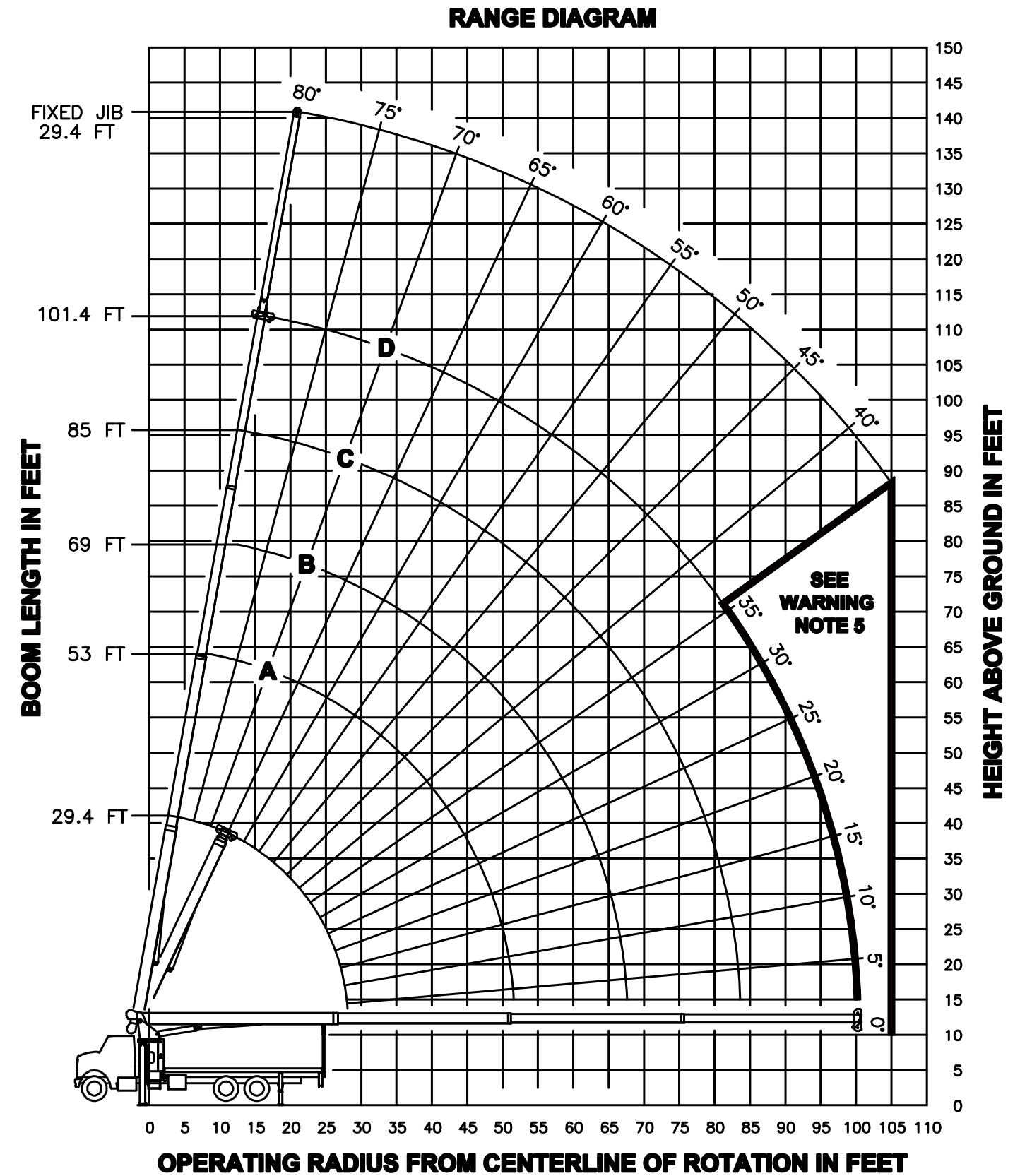

Data published herein is intended as a guide only. Crane operations is subject to machine specific load charts and information.

# LOAD CHART: Main Boom & Jib

4-section Boom 29.44 ft.- 101.44 ft.

21'-6" (6,5 M)

372° Non-continuous

Jib 29 ft.

Load Ratings in LBS with Outriggers and Stabilizers Extended										Jib Load Ratings in LBS with Outriggers and Stabilizers Extended			
LMI Code #1										LMI Code #2			
Loaded Boom Angle (ft.)	Boom Length & Marker (ft.)									Loaded Boom Angle (ft.)	Jib Length for All Boom Lengths		
		A (lbs.)	B (lbs.)	C (lbs.)	D (lbs.)	E (lbs.)	F (lbs.)	G (lbs.)	H (lbs.)		I (ft.)	J (ft.)	
5	80	52,000								10			
8	74	37,390								10			
10	70	31,750								10			
12	66	27,740	78	14,000						12			
14	61	24,720	76	14,000	80	14,000				14			
17	54	21,200	72	14,000	78	12,880				17			
20	46	18,030	69	13,700	75	11,430	79	8,920		20			
25	29	14,120	63	11,070	71	9,460	75	8,000	79	6,000	25		
30			56	9,170	66	8,210	72	7,070	76	5,500	30	80	3,000
35			49	7,850	61	6,970	68	6,130	73	4,980	35	78	2,840
40			41	6,120	56	5,980	65	5,320	70	4,490	40	76	2,620
45			31	4,890	51	5,020	61	4,640	67	4,000	45	73	2,420
50			17	3,950	45	4,090	57	4,070	64	3,580	50	71	2,230
55					38	3,370	52	3,440	61	3,200	55	69	2,020
60					30	2,790	47	2,860	57	2,850	60	67	1,840
65					19	2,310	42	2,390	54	2,430	65	64	1,670
70							36	1,990	50	2,040	70	62	1,520
75							29	1,650	45	1,700	75	59	1,380
80							20	1,360	41	1,420	80	56	1,230
85									36	1,160	85	53	1,080
90									30	950	90	50	950
95									22	750	95	47	830
100									3	570	100	44	690
105											105	40	530
		340 lbs.	190 lbs.	150 lbs.	120 lbs.	100 lbs.	Deductions for stowed fixed jib						

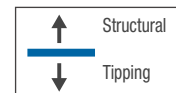

**NOTES:**

- Loads based on crane on fully extended outriggers
- All "on outriggers" loads are based on 85% tipping
- Loads above heavy line are based on structural rating
- Loads below heavy line are based on tipping rating

Data published herein is intended as a guide only. Crane operations is subject to machine specific load charts and information.

# LMI OPERATING CODES

Code	Crane Configuration	Outrigger Configuration	Area of Operation
#1	Main Boom	Fully Extended	372° Non-continuous
#2	Fixed Jib	Fully Extended	372° Non-continuous
#5	Personnel lifting platform on main boom	Fully Extended	372° Non-continuous
#6	Personnel lifting platform on fixed jib	Fully Extended	372° Non-continuous

**WARNING:** Lifting personnel from extended jib is not approved.

# REEVING DIAGRAM

ALLOWABLE LINE PULL							<b>WARNING</b>
1 PART LINE	2 PART LINE	3 PART LINE	4 PART LINE	5 PART LINE	6 PART LINE	7 PART LINE	
8500 LBS	17000 LBS	25500 LBS	34000 LBS	42500 LBS	51000 LBS	52000 LBS	<p>ANTI-TWO-BLOCK SYSTEM MUST BE IN GOOD OPERATING CONDITION BEFORE OPERATING CRANE.</p> <p>REFER TO THE OWNER'S MANUAL.</p> <p>KEEP AT LEAST 3 WRAPS OF LOAD LINE ON THE DRUM AT ALL TIMES.</p> <p>9/16" 6X25 IWRC (3.5:1 SF) - 29750 LBS MIN BREAKING STRENGTH</p> <p>9/16" ROT RESISTANT (5.0:1 SF) - 37000 LBS MIN BREAKING STRENGTH</p>
7400 LBS	14800 LBS	22200 LBS	29600 LBS	37000 LBS	44400 LBS	51800 LBS	
<p><b>DEDUCTIONS FROM RATED LOADS FOR LOAD HANDLING DEVICES SUPPLIED BY MANITEX.</b></p> <p>AUXILIARY BLOCK ----- 50 LBS</p> <p>AUXILIARY SHEAVE ----- 50 LBS</p> <p>OVERHAUL BALL ----- SEE OVERHAUL BALL MFR. NAMEPLATE</p> <p>LOAD BLOCK ----- SEE BLOCK MFR. NAMEPLATE</p> <p>HOSE REEL ----- 140 LBS</p> <p>SWING AROUND JIB ----- SEE LOAD CHART</p>							
<p><b>WARNING</b></p> <p>LIFTING OFF THE MAIN BOOM POINT WHILE THE JIB IS ERECTED IS NOT INTENDED OR APPROVED.</p>							

Data published herein is intended as a guide only. Crane operations is subject to machine specific load charts and information.